

1110±20

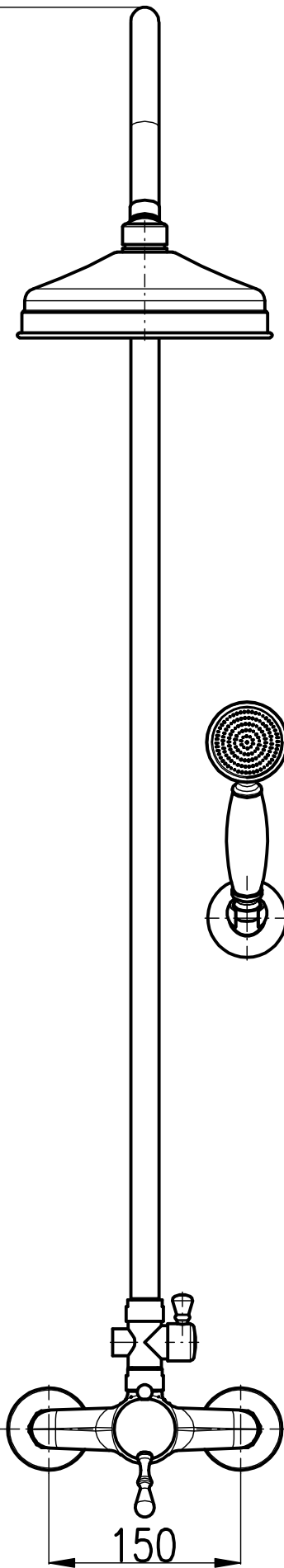

150

490±20

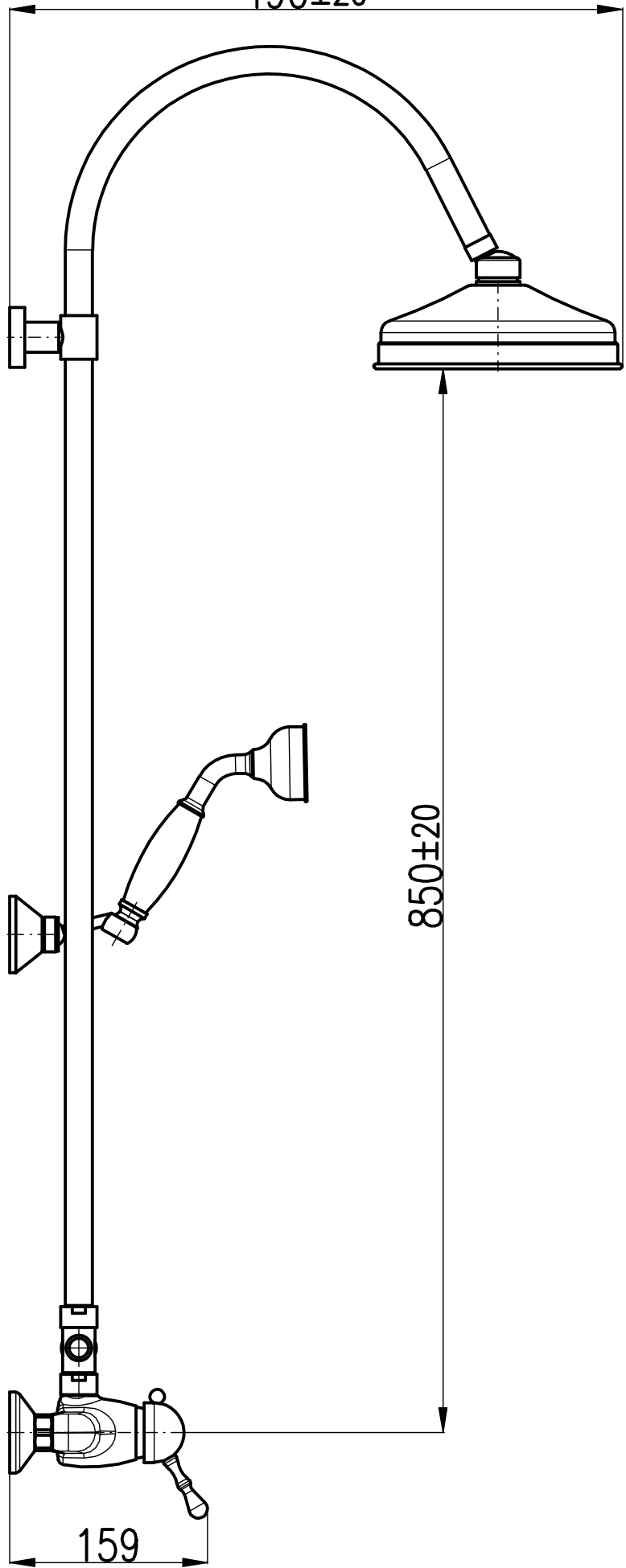

850±20

159